

OPERATING INSTRUCTIONS



TYPE **631-BL**

STROBOTAC

G E N E R A L R A D I O C O M P A N Y

OPERATING INSTRUCTIONS

TYPE **631-BL**

STROBOTAC

Form 394-X
September, 1959

GENERAL RADIO COMPANY
WEST CONCORD, MASSACHUSETTS, USA

**CONDENSED OPERATING INSTRUCTIONS
FOR
TYPE 631-BL STROBOTAC®**

TO OPERATE

1. Connect to a-c power line. See socket plate for correct voltage and frequency.
2. Set toggle switch at rear to DIRECT.
3. Set rotary panel selector switch to STROBOTAC LOW for 600 to 3600 rpm, or STROBOTAC HIGH for 2400 to 14,500 rpm.
4. Shine light from lamp at element to be observed.
5. Adjust RPM scale until a single stationary image is seen.
6. After Strobotac has been calibrated (see below), correct speed is the highest speed reading of the RPM scale producing a single image.
7. To watch equipment in slow motion, adjust the flashing speed to be slightly less than the speed of the element being observed.
8. For speeds below 600 or above 14,500 rpm, and for use of LINE and CONTACTOR positions, see pages 6 and 8.

TO CALIBRATE*

- A. Allow Strobotac to warm up for several minutes with rear toggle switch at DIRECT and panel selector switch at STROBOTAC LOW.
- B. Press, then release, REED button at rear to turn on the reed.
- C. Set RPM scale to 3600 rpm (top end of low scale).
- D. Adjust the 3600 ADJUST trimmer until a single stationary reed image is seen.
- E. Set RPM scale to 1800 rpm.
- F. Adjust the 900 ADJUST trimmer until the reed again stands still.
- G. Set RPM scale to 900 rpm.
- H. Slightly readjust 900 ADJUST trimmer until the reed again stands still.
- I. Recheck at 3600 and at 900 rpm, readjusting trimmers if necessary.
- J. Press REED button to turn off the reed.

*For 60-cycle service; see page 5 also.

NOTE: These condensed instructions are reproduced on back panel of Strobotac.

PATENT NOTICE

The Strobotac is manufactured under designs and patent applications of Harold E. Edgerton, Kenneth J. Germeshausen and Herbert E. Grier.

OPERATING INSTRUCTIONS

for

TYPE 631-BL STROBOTAC[®]

1.0 PURPOSE

The Type 631-BL Strobotac is a stroboscopic tachometer. It provides a rapid and accurate means of measuring directly speeds between 600 and 14,400 rpm and, by indirect methods, speeds up to at least 50,000 rpm. An additional low range is provided extending down to 60 rpm. It is particularly adapted for the measurement of speed where the end of the shaft is not accessible or in cases where the power is limited. It does not require mechanical contact with the shaft and absorbs no power from the drive. The Strobotac can also be used for stroboscopic observation of moving objects, and for controlling the flashing rates of the Type 648 Strobolux and the Type 1532 Strobolume.

2.0 DESCRIPTION

The Strobotac consists of a power supply, an oscillator for controlling the rate at which the lamp is flashed, and a Strobotron or flashing lamp -- all assembled in a single unit. By turning an illuminated dial, the frequency of the oscillator and hence the flashing speed of the lamp can be adjusted to any value between 60 and 14,400 per minute. The scale of the dial is graduated directly from 600 to 14,400 rpm and the lamp flashes at these speeds when the toggle switch at the rear of the instrument is in the DIRECT position. When this switch is in the SLOW position the flashing rate is approximately one-tenth the indicated scale value. Thus when used with the main scale selector switch in the LOW position, the range is about 60 to 360 rpm and in the HIGH position about 240 to 1440 rpm. The entire assembly is housed in a metal case, is easily portable, and operates from an a-c line.

2.1 FLASH CONTROL

In addition to the self-contained oscillator, provision is made for controlling the speed of the flash by means of the a-c line frequency, or by means of an external contact or oscillator.

GENERAL RADIO COMPANY

2.2 CALIBRATION

Provision is made for adjusting the internal oscillator frequency in terms of the a-c line frequency in order to compensate for drifts in the calibration. For maximum accuracy, therefore, the Strobotac should be used only on frequency-controlled power lines, i.e., those on which synchronous electric clocks can be used.

2.3 ACCURACY

The dial carries two scales, one covering speeds between 600 and 3600 rpm and the other speeds between 2400 and 14,400 rpm. Between 900 and 3600 on the low scale and between 3600 and 14,400 on the high scale the accuracy of the Strobotac is $\pm 1\%$ of reading, when properly standardized in terms of a frequency-controlled power line. Outside these limits the accuracy may not be so good. It is possible, however, to standardize the scale over any small range in terms of the line frequency and to obtain accuracies considerably better than 1% (see paragraph 6.1).

When used on the SLOW position, the flashing rates are about one-tenth the scale values. These ranges are provided primarily for observational work and no accuracy specification applies to these rates. However, duplication of rates at given dial settings is generally reliable.

2.4 CIRCUIT

Figure 3 is a complete circuit diagram.

2.5 VACUUM TUBES

Three vacuum tubes are used, one 6X5-GT/G-type, one 6N7-GT/G-type and one Type 631-P1 Strobotron.

2.6 STROBOLUX

A jack is provided so that connection can be made to the Type 648 Strobolux (a self-contained lamp and power supply) which, at the lower flashing rates, gives many times the amount of light produced by the Strobotac and, in some cases, may be used as a source of illumination for taking "high-speed" photographs.

2.7 STROBOLUME

Where greater flash intensity is required, the Type 1532 Strobolume can be controlled from the Strobotac. Connection is made at the STROBOLUX jack on the Strobotac by means of a Type 1532-P2 Transformer-Cable.

2.8 CONTACTOR

When it is desirable to flash the Strobotac in exact synchronization with a rotating shaft, the Type 1535 Contactor can be used. See paragraphs 3.11 and 4.6.2.

3.0 OPERATION

(Numbers in parentheses refer to Figure 1)

3.1 INSTALLATION

Connect the Strobotac to the power line by means of the cord and plug provided. Be sure the voltage and frequency of the a-c line correspond to those engraved above the line receptacle (1). This receptacle is located in the rear lower right corner of the unit.

3.11 Switches

A rotary switch (4) is provided to enable the user to select easily and rapidly the desired condition of operation. The first position, OFF, with the pointer turned fully to the left, is a non-operating point, the power being turned off. The second and third (STROBOTAC) positions are for speed measurements. The LOW position is for speed from 600 to 3600 rpm (with the toggle switch at the rear in the DIRECT position), and the scale marked LOW (right-hand) should be used. The third (HIGH) position is for the higher scale which is four times the low, 2400 to 14,400; the scale is marked HIGH and is the left-hand section of the dial. In the fourth or top center position (LINE), the lamp is controlled by the frequency of the power line. If operated on a 60-cycle circuit, the flashes will be 3600 per minute (exact line frequency). The last two (CONTACTOR) positions are for contactor or external oscillator control. The LOW position is for speeds up to about 3600 rpm, while above this the HIGH position will give the best results up to the maximum for the instrument of about 15,000 rpm. The Type 1535 Contactor is recommended for speeds up to about 5000 rpm.

When the rear range switch is at SLOW, the second and third positions of switch (4) produce speeds about one-tenth of those given above. The LINE position of switch (4) may not give reliable results in the SLOW range.

3.2 ADJUSTMENT

Turn selector switch (4) to STROBOTAC LOW position. The light will flash in about 15 seconds. Usually a minute or more should be allowed for heating before expecting normal operation.

3.22 Scale

An illuminated drum dial (5) is provided which is read through a window in the top of the instrument. The instrument may be held by the left hand, leaving the right hand free to operate the speed control knob. In the Type 631-BL Strobotac, the scale may be read from above without moving or setting down the instrument. The right-hand scale is for low speeds from 600 to 3600 rpm. To provide larger and more easily readable figures, the two zeros on the left have been omitted; thus, 18 should be read as 1800. The HIGH scale (left) has been planned in the same manner. The note "MULTIPLY BY 100" at the right of the window is a reminder to add the two zeros, which is simply shifting the decimal point two places to the right, a reading of 72.5 becoming 7250 rpm.

On the SLOW ranges, the dial readings should be divided by 10 (add only one zero to the scale figures).

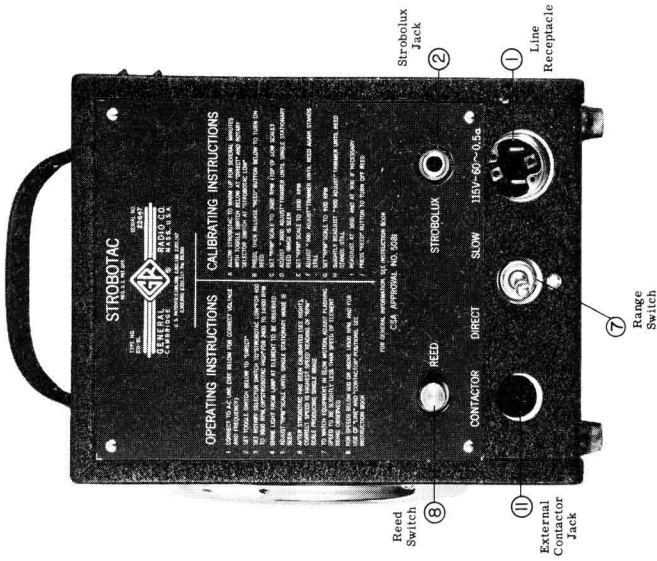
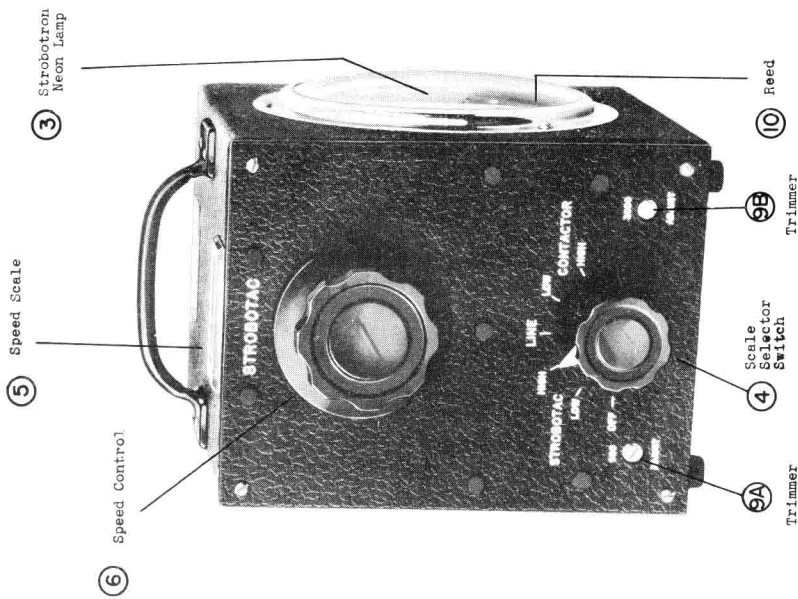

Rear View of Strobotac

Figure 1.

Panel View of Strobotac

TYPE 631-BL STROBOTAC

3.3 STANDARDIZATION

The Strobotac is standardized in terms of the a-c line frequency by using the metal reed (10) which projects through the lamp reflector. This reed is driven from the a-c power line, and with 60-cycle supply vibrates 7200 times per minute, or twice for each cycle of line voltage. When the Strobotac flashing rate corresponds to this reed vibration rate, a multiple of it, or a submultiple, the reed will appear to stand still. The points on the Strobotac dial at which this occurs can then be used to standardize the dial calibration. The absolute accuracy of this calibration depends on the accuracy to which the line frequency is maintained at the power station; in most localities where synchronous electric clocks are used it is better than 0.1 of 1%.

3.31 Procedure for 60-Cycle Service (For other line frequencies, see 3.32, Below)

Turn on reed by pushing REED button (8) at left rear of instrument. Set RPM scale to 3600 on the low scale, with the switch set at STROBOTAC LOW (toggle switch at DIRECT). Using a small screw driver, adjust trimmer (9B) marked ADJUST 3600 until reed shows no motion. Turn scale to 1800 and adjust in a similar manner trimmer (9A) marked ADJUST 900. Next, turn scale to 900 and again readjust the 900 trimmer to make the reed stand still. Re-check the setting at 3600 and again at 900. As a final check, set the dial at 1800 and at 1200. At each of these settings the reed should be stopped or show a very slow motion. Always make this check. While the ratio between LOW and HIGH scales is almost exactly 4 to 1, and both scales are accurate enough for general use when only the LOW scale has been standardized, it is suggested that for very accurate high-speed measurements the high scale be standardized, using 3600 and 14,400 and making adjustments using the 900 and 3600 trimmers, respectively. A double image will be obtained at 14,400.

3.32 Other Line Frequencies

Although the standard Strobotac will operate on any 115-volt a-c line having a frequency between 55 and 65 cycles, the points at which the scale is set for standardization will be different for each frequency. In general, any submultiple of the line frequency expressed in cycles per minute can be used. The standardizing speeds should be near the ends of the scale. For 50 cycles, for instance, 750 and 3000 might be used. When the Strobotac is ordered for use on a specific frequency, the calibrating speeds are engraved on the panel.

The following frequencies are ordinarily used:

Line Frequency	60	50	45	42	40	25
Reed Frequency	7,200	6,000	5,400	5,040	4,800	3,000
Set Trimmer 9A at	900	750	900	840	800	750
Set Trimmer 9B at	3,600	3,000	2,700	2,520	2,400	3,000
Final Check Speeds	1,800 1,200	1,500 1,000	1,800 1,080	1,680 1,260	1,600 1,200	1,500 1,000
High Scale, 9A	3,600	3,000	2,700	2,520	4,800	3,000
High Scale,	14,400*	12,000*	10,800*	10,080*	14,400**	12,000***

*Double image

**Triple image

***Quadruple image

4.0 USE

4.1 SPEED MEASUREMENT

In using the Strobotac to measure the speed of rotating or reciprocating mechanisms, hold the instrument so that the light from the neon lamp falls on the part to be observed and adjust the knob (6) until the moving part appears to stand still. The scale (5) gives the speed directly in rpm. In cases where no idea of the speed being measured is known, it is desirable to start at high speeds and work down. At twice the speed the pattern is doubled and the first time a true pattern is obtained (fundamental synchronism, see paragraph 4.3, below), the dial reading gives the correct speed.

4.11 High Speeds

Since the life of the Strobotron tube (3) is much greater when flashed at low speeds than at high, the **LOW** scale should be used whenever possible. When measuring speeds of objects above 5000 rpm, the Strobotac can be adjusted at higher speed, after which the switch is turned to **LOW**. The pattern seen will still be stationary because of the 4:1 relationship between **HIGH** and **LOW** scale. The accuracy of the measurement is not affected. A slight twist of the knob restores the high speed when desired.

4.2 SUBMULTIPLES

If the lamp is flashed at a speed which is a submultiple ($1/2$, $1/3$, $1/4$, .. $1/n$) of the speed of the rotating part under observation, the motion can be "stopped" in a manner identical with that at fundamental synchronism. The highest scale reading at which a single stationary image is obtained is, therefore, the correct setting.

4.3 FUNDAMENTAL SYNCHRONISM

When adjusting for fundamental synchronism, a convenient and safe procedure is to start at high speeds where multiple images are obtained and reduce the flash speed until a single image occurs.

In most work the approximate speed is known and submultiple effects need not be considered. When using the Strobotac to view rotating objects such as the end of a shaft or a wheel with a number of identical spokes, a chalk mark or some other positive means of identification should be made on the rotating part, otherwise it is possible to obtain erroneous readings, although the subject which is being viewed may appear to be standing still. The chalk mark provides a positive means of identification since if only one mark is seen, it is certain to be either fundamental synchronism or a submultiple thereof.

4.4 MULTIPLE SYNCHRONISMS

If the speed of the lamp is n times the speed of the subject, n patterns will be seen. This is covered more fully in paragraph 5.2.

TYPE 631-BL STROBOTAC















	SHAFT SPEED "R"	FLASH SPEED "F"	APPEARANCE	SPEED EQUATIONS	REMARKS
a	0	0			MACHINE STOPPED LAMP OFF
b	1800 R.P.M. 	0			MACHINE RUNNING LAMP OFF SPOT INVISIBLE
c	1800 R.P.M. 	1800 F.P.M.		$R = F$	FUNDAMENTAL SYNCHRONISM
d	1800 R.P.M. 	$\left. \begin{matrix} 900 \\ 600 \\ 1800/n \end{matrix} \right\} \text{ F.P.M.}$ ("n" IS INTEGER)		$F = \frac{R}{n}$	PERFECT SYNCHRONISM LESS ILLUMINATION ON SPOT THAN "C"
e	1800 R.P.M. 	3600 F.P.M.		$F = nR$ ($n = 2$)	PARTIAL SYNCHRONISM
f	1800 R.P.M. 	7200 F.P.M.		$F = nR$ ($n = 4$)	PARTIAL SYNCHRONISM
g	1800 R.P.M. 	1799 F.P.M.		$S = R - F$ ("S" IS SPEED OF SLOW MOTION)	SLOW ROTATION (I.R.P.M.) IN SAME DIRECTION AS TRUE ROTATION.
h	1800 R.P.M. 	1801 F.P.M.		$S = F - R$ ("S" IS SPEED OF SLOW MOTION)	SLOW ROTATION (I.R.P.M.) IN OPPOSITE DIRECTION TO TRUE ROTATION

Figure 2.

GENERAL RADIO COMPANY

4.5 SLOW-MOTION STUDIES

Stroboscopic methods of apparently slowing down high-speed motion can be used only where the motion is cyclic, that is, rotating or reciprocating at approximately constant speeds. See (g) and (h), Figure 2. For best results, a semi-darkened room should be used, although satisfactory work can often be done under normal factory illumination. When more light is needed than the Strobotac supplies, use the Type 648 Strobolux or Type 1532 Strobolume.

4.6 OTHER FLASHING SOURCES

4.61 Control by A-C Line

To secure flashing at the same rate as the line frequency (3600 rpm on 60-cycle circuits), which may be used to observe hunting of certain classes of electrical machinery or to measure speeds or slip of small motors, set the selector switch to the **LINE** position. The frequency of the oscillator is then exactly the same as the line frequency.

4.62 Use of Contactor

A commutator or contactor such as the General Radio Type 1535 Contactor can also be used to control flash speed. Connect the contactor to the receptacle (11) at the lower left-hand corner of the rear of the instrument by means of the plug provided. If it is not convenient to rewire the Type 1535 Contactor with this plug, an adaptor cable, Type 1535-P1, can be obtained for connecting the Type 1535 directly to the Strobotac.

Turn the selector switch to **CONTACTOR** position. For speeds up to 3600 rpm, use contactor **LOW**; above this, turn switch to contactor **HIGH**. Maximum illumination is obtained in the contactor **LOW** position.

4.63 Oscillator Control

Any audio-frequency oscillator having an output of approximately 100 volts may be used to drive the Strobotac if desired. Connections may be made through contactor jack (11). The range is usually somewhat more limited than the full scale of the Strobotac, and the accuracy is that of the oscillator.

5.0 EXTENSION OF RANGE

Multiple and submultiple synchronisms can be used to extend the range of the Strobotac to higher and lower speeds.

5.1 IDENTIFICATION OF HIGHER SPEEDS

When the speed of the shaft under observation is greater than that of the flash, change the flash speed until the next point of synchronism is obtained. From the two dial readings the shaft speed can be calculated. If the two dial readings are a and b, the shaft speed is given by $\frac{ab}{a-b}$, when a is the larger of

TYPE 631-BL STROBOTAC

the two readings. As an example, suppose the two dial readings are 4500 and 4000. The shaft speed is then $\frac{4500 \times 4000}{4500 - 4000} = 36,000$ rpm.

For very high speeds, the value $a-b$ becomes progressively smaller, with a consequently larger error in the result. This can be avoided by taking a and b several patterns apart and using the expression $\text{rpm} = n \frac{ab}{a-b}$, when n is the number of patterns reached in going from a to b . As an example, consider the shaft speed measured in the preceding example. One reading is obtained at 4000, another at 7200. In going from 4000 to 7200, the number of patterns encountered is 4. Hence,

$$4 \times \frac{7200 \times 4000}{7200 - 4000} = 36,000 \text{ rpm.}$$

5.2 LOWER SPEEDS

If the lamp is flashed at a rate corresponding to a multiple of the shaft speed, multiple images can be seen. For instance, a radial line on the end of the shaft will appear as several lines, spaced equally around the circumference. Twice the speed will produce two lines at 180° , three times yields three lines at 120° intervals, etc. Dividing the flash speed by the number of lines seen will then give the shaft speed. This method is not recommended for very low speeds except when used in a darkened room, since rates below the persistence of vision (about ten flashes per second) are difficult to determine.

6.0 ADDITIONAL SUGGESTIONS

6.1 ADDITIONAL CALIBRATION POINTS

As the scale reading is changed slowly with the REED switch in the ON position, a number of points of synchronism will be found. Some of these produce one image, others two, three or four. Because of the difficulty of interpreting the multiple images, it is recommended that no patterns more complicated than double images be used. The frequency of the reed is 7200 vibrations per minute for 60-cycle supply. If the dial is set at any integral submultiple of 7200, a single image of the reed will appear to stand still. For 60-cycle supply, these points will be found at the following speeds: 7200, 3600, 2400, 1800, 1440, 1200, 900, 800, 720, and 600. In addition, fractional relations producing a double image can be obtained at a number of points as, for instance, 1600 rpm, where the ratio of the flashing speed to the reed speed is $\frac{2}{9}$. For these fractional relations, the ratio of flash speed to reed speed can be reduced to lowest terms, after which the numerator of the fraction indicates the number of patterns seen. Since, however, there are so many integral submultiples which yield a single image, it will not usually be found necessary to use the fractional relationships.

GENERAL RADIO COMPANY

When the flashing speed is greater than the speed of the reed, a large number of stationary patterns can be found. Most of these, however, are fractional multiples and are somewhat difficult to interpret. A double image can be found at 14,400 which is twice the speed of the reed. A triple image occurs at 10,800 corresponding to a ratio of the $3/2$. It is not recommended that images with a greater number of lines be used. See Table I.

All these points are useful in calibrating the scale. The directions for calibration given in paragraph 3.31 cover the standardization to the entire scale. If, however, it is desired to measure accurately the speed of rotating machinery over a small range, or to measure deviations from a given standard speed, the scale can be adjusted by means of the trimmers (9) to be accurate, at the nearest point where a reed synchronism is obtained, or at two points at the ends of the range in which the measurements are to be made. Under these conditions, an accuracy far in excess of 1% can be obtained.

6.11

Figure 2 shows briefly the multiple and submultiple relationships discussed above, as well as the effect which occurs when the flash speed differs very slightly from the speed of the subject.

For obtaining patterns like those shown in the table, a small synchronous motor carrying a disc with spots, as shown, is useful. This can also be used for calibration purposes instead of the reed. Table II gives a list of speeds for images up to 5 spots, with an 1800 rpm disc, bearing one spot.

7.0 MAINTENANCE

7.1 STROBOTRON LIFE

The Strobotron tube is guaranteed for 250 hours if used at flashing speeds of less than 5000 rpm, or for 100 hours if used at higher speeds, with both of these guarantees limited to 60 days after date of shipment from our plant. Any tubes that become defective or unsatisfactory within the 60-day time limit will be replaced by the General Radio Company on a pro-rata basis, if the customer will advise us of the length of time that the tube was used and at what flashing speeds.

7.2 EFFECT OF FLASHING SPEED

If the Strobotac is operated continuously at the higher speeds, the Strobotron cathode emission may eventually be reduced to the point where the tube is inoperative. When this occurs, the tube usually glows with a dull red color, but will not flash. Flickering is another symptom of this condition. Operation can often be restored by running the tube at low speeds for several hours. Eventually, however, the tube becomes completely inoperative and must be replaced.

TYPE 631-BL STROBOTAC

7.3 REPLACEMENT STROBOTRONS

To replace Strobotron or other tubes, the entire unit may easily be withdrawn from case. Four screws hold front panel and one screw is located in the rear. Always replace rear screw as this locks the chassis in the cabinet. DO NOT REMOVE lens to replace Strobotron.

7.4 OTHER TUBES

Type 6X5-GT/G and 6N7-GT/G Tubes can be obtained from any radio store.

7.5 FRICTION DRIVE

This instrument is equipped with a slow-motion friction drive. Take-up adjustment can be made by removing the knob, loosening the screw in the ear of the clamp ring, and turning the brass disc slightly to the right, using the notch in the edge. Only a very slight motion is required, and adjustments need be made only after long periods of use. Be sure to tighten the clamp screw after adjusting.

TABLE I

ADDITIONAL REED CALIBRATING POINTS
LOW SCALE

Reed Speed	Dial Setting	Number of Images	<u>Dial Speed</u> <u>Reed Speed</u>
7200*	600	1	1/12
	626.1	2	2/23
	654.5	1	1/11
	685.7	2	2/21
	720	1	1/10
	757.9	2	2/19
	800	1	1/9
	847.1	2	2/17
	900	1	1/8
	960	2	2/15
	1028.6	1	1/7
	1107.7	2	2/13
	1200	1	1/6
	1309.1	2	2/11
	1440	1	1/5
	1600	2	2/9
	1800	1	1/4
	2057.1	2	2/7
2400	1	1/3	
2880	2	2/5	
3600	1	1/2	

*For 60-cycle service. For other reed speeds (see paragraph 3.32), dial settings can be calculated using the ratios in column 4.

GENERAL RADIO COMPANY

TABLE II
 CALIBRATING POINTS USING 1800-RPM
 SYNCHRONOUS MOTOR WITH ONE-SPOT DISK
 POINTS BELOW 1800 RPM

Disk Speed	Dial	Spots Seen	$\frac{\text{Dial Speed}}{\text{Disk Speed}}$
1800 †	1800	1	1
	1500	5	5/6
	1440	4	4/5
	1350	3	3/4
	1285.7	5	5/7
	1200	2	2/3
	1125	5	5/8
	1080	3	3/5
	1028.6	4	4/7
	1000	5	5/9
	900	1	1/2
	818.8	5	5/11
	800	4	4/9
	771.4	3	3/7
	750	5	5/12
	720	2	2/5
	692.3	5	5/13
	675	3	3/8
	654.5	4	4/11
	642.9	5	5/14
	600	1	1/3

POINTS ABOVE 1800 RPM

Disk Speed	Dial	Spots Seen	$\frac{\text{Dial Speed}}{\text{Disk Speed}}$
1800 †	1800	1	1
	2400	4	4/3
	2700	3	3/2
	3600	2	2
	4500	5	5/2
	5400	3	3
	7200	4	4
	9000	5	5
	10,800	6	6
	12,600	7	7
	14,400	8	8

† For other disk speeds, dial settings can be calculated using the ratios in column 4.

SERVICE AND MAINTENANCE INSTRUCTIONS
for
TYPE 631-BL STROBOTAC

1.0 FOREWORD

1.1 These Service Instructions together with the information given in the Operating Instructions should enable the user to locate and correct ordinary difficulties resulting from normal usage.

1.2 Most of the components mentioned in these instructions can be located by referring to the photographs.

1.3 Major service problems should be referred to the Service Department which will cooperate as far as possible by furnishing information and instructions, as well as by shipping any replacement parts which may be required.

1.4 Detailed facts giving type and serial numbers of the instrument and parts, as well as operating conditions, should always be included in your report to the Service Department.

2.0 GENERAL

If the Strobotac becomes inoperative, a few simple checks should be made before removing the instrument from its case.

2.1 Check that the voltage and power line frequency of the power source agree with those marked on the Strobotac.

2.2 Test the power supply cord for open circuits or for poor contacts in the power outlets.

3.0 STROBOTAC INOPERATIVE

3.1 Dial lamp does not light; refer to Section 4.0.

3.2 Reed will not vibrate; refer to Section 5.0.

GENERAL RADIO COMPANY

3.3 Strobotac blows fuses; refer to Section 6.0.

3.4 Dial lamp burns dimly; Strobotac draws excessive power; refer to Section 7.0.

3.5 Strobotron tube, V-3, flashes erratically; refer to Section 8.0.

3.6 Indicated flashing speed differs by more than one percent between HIGH and LOW scales; above 900 rpm on DIRECT, refer to Section 9.0.

3.7 3600 rpm cannot be set by 3600 ADJUST trimmer; refer to Section 10.0.

3.8 900 rpm cannot be set by 900 ADJUST trimmer; refer to Section 11.0.

3.9 Strobotac will not calibrate properly; refer to Section 12.0.

3.10 Main speed control knob binds; refer to Section 13.0.

3.11 Main speed control knob has backlash; refer to Section 14.0.

3.12 Vacuum tube data, refer to Section 15.0.

3.13 Capacitor Voltages - D.C., refer to Section 16.0.

4.0 DIAL LAMP DOES NOT LIGHT

4.1 Test lamp P-1 for an open filament.

4.11 The lamp can be reached by turning the main scale and hub assembly so that the punched slot in the hub is opposite the lamp. The entire lamp socket assembly can then be withdrawn using a pair of long-nose pliers.

4.2 Test fuses F-1 and F-2 for open circuits.

4.3 Check switch S-4 for proper operation.

4.4 Test transformer T-1 for continuity of windings.

5.0 REED WILL NOT VIBRATE

5.1 Measure the voltage across the coil with an a-c voltmeter. The voltage should be approximately 6.3 v. a.c.

5.2 Test REED switch S-5 for proper operation.

5.3 Test the coil for an open circuit.

5.4 Test transformer T-1 for continuity of windings between pins #3 and #4.

5.5 Refer to Section 4.0.

TYPE 631-BL STROBOTAC

6.0 STROBOTAC BLOWS FUSES

6.1 Check tube V-1 (6X5-GT/G) and operating voltages; refer to Section 15.0. Replace if necessary.

6.2 Test capacitors C-8, C-9, and C-11 for short circuits.

6.3 Check for accidental short circuits to ground.

7.0 DIAL LAMP BURNS DIMLY; STROBOTAC DRAWS EXCESSIVE POWER

Normal input power is approximately 35 watts.

7.1 Check that the reed coil does not have one side short-circuited to ground.

7.2 Check tube V-2 for internally short-circuited elements.

8.0 STROBOTRON TUBE, V-3, FLASHES ERRATICALLY

8.1 Strobotron flashes erratically at high end of HIGH scale.

8.11 The tube is at the end of its useful life and should be replaced.

8.2 Strobotron flashes erratically on either or both CONTACTOR HIGH or LOW positions.

8.21 Replace the Strobotron tube.

8.3 Strobotron flashes erratically on LINE position of switch.

8.31 Replace the Strobotron tube.

8.4 Strobotron flashes correctly on the LOW scale but glows steadily on the HIGH scale.

8.41 Replace capacitor C-1.

8.5 Strobotron tube flashes at the same rate regardless of dial setting on either HIGH or LOW scale.

8.51 The RPM rheostat R-13 is probably open circuited. If the break is at one end the wire may possibly be reconnected; otherwise, the rheostat should be replaced.

8.6 Strobotron tube flashes erratically on the low end of the HIGH scale only.

8.61 The tube is oversensitive. It can possibly be corrected by short-circuiting pin #1 on the Strobotron tube socket to ground for 2 or 3 minutes, or until the condition clears up. This should not exceed 8 to 10 minutes at the maximum. The

GENERAL RADIO COMPANY

result is to burn some of the Caesium off the tube elements. Care should be taken not to remove too much thereby shortening the tube life.

8.7 Flashing rate is jumpy or tends to lock-in at certain speeds.

8.71 Check capacitors C-8, C-9, and C-11 for intermittent electrical breakdown. Replace capacitors if necessary.

8.8 Strobotron life:

The Strobotron tube is guaranteed for 250 hours if used at flashing speeds of less than 5000 RPM, or for 100 hours if used at higher speeds, with both these guarantees limited to 60 days after the date of shipment from our factory. Any tubes that become defective or unsatisfactory within this 60 day period will be replaced by the General Radio Company on a pro-rata basis upon the receipt of information as to the length of time that the tube was used and at what flashing speeds.

9.0 INDICATED FLASHING SPEED DIFFERS BY MORE THAN ONE PERCENT BETWEEN HIGH AND LOW SCALES

9.1 Try replacing tube V-2 (6N7-GT/G). It may be necessary to try several tubes before a satisfactory one can be found.

9.2 If the HIGH scale reads too high try shunting capacitors C-4 and C-5 with about 200 mmf capacity each.

10.0 3600 RPM CANNOT BE SET BY 3600 ADJUST TRIMMER

10.1 Test rheostat R-12 for an open circuit and for proper resistance value.

10.2 Test resistor R-16 for open or short circuit and for proper value.

10.3 Check that the scale assembly is not loose and that it has not slipped on its shaft.

11.0 900 RPM CANNOT BE SET BY 900 ADJUST TRIMMER

11.1 Check 900 ADJUST rheostat, R-11, for an open circuit and for proper resistance value.

11.2 Check that the scale assembly is not loose and that it has not slipped on its shaft.

TYPE 631-BL STROBOTAC

11.3 Try replacing the 6N7-GT/G tube, V-2. It may be necessary to try several such tubes until a satisfactory one is found.

11.4 Try installing a resistor of about 2700 - 3000 ohms from pin #8 (cathode) of the 6N7-GT/G tube to ground (chassis).

12.0 STROBOTAC WILL NOT CALIBRATE PROPERLY .

12.1 It sometimes happens that there are two settings of the 900 ADJUST trimmer that will stop motion at 900 RPM. Choosing the incorrect setting will make the rest of the scale read incorrectly.

12.2 The correct setting will be chosen automatically by following the calibration procedure shown in page i of the Operating Instructions.

13.0 MAIN SPEED CONTROL KNOB BINDS

13.1 Check that the knob is not too close to the panel.

13.2 Check that wires inside the instrument are not interfering with the drum rotation.

13.3 Check that the drum assembly is not pushed too far toward the panel on its shaft.

13.4 If the shaft appears to bind in the main RPM rheostat, lubricate it with a small amount of petrolatum (unmedicated Vaseline).

14.0 MAIN SPEED CONTROL KNOB HAS BACKLASH

14.1 The Strobotac has a slow motion (planetary) friction drive. Take-up adjustment can be made by removing the knob, loosening the screw in the ear of the clamp ring and turning the brass disc slightly to the right. Use the notch in the edge to turn the disc. Only a slight motion is necessary and should be made only after long periods of use. Make certain that the clamp screw is tightened after making adjustments.

GENERAL RADIO COMPANY

15.0 VACUUM TUBE DATA

Table of tube socket voltages measured from socket pin to ground, unless otherwise indicated, using a 20,000 ohm-per-volt meter (Weston 772 Analyzer). D-C voltages may vary $\pm 20\%$.

SYMBOL	TYPE	SOCKET PIN NUMBER								FUNCTION
		1	2	3	4	5	6	7	8	
V-1	6X5-GT/G	0	2 and 7 6.3v AC	213v AC	--	213v AC	--	--	255	Rectifier
V-2	6N7-GT/G	0	2 and 7 6.3v AC	72	-26.5	-26.5	75	--	0	Oscillator
V-3	631-P1	27.5	125	3.8	0	--	--	--	--	Flash Tube

CONDITIONS:

Input - 115 v., 60 cycles, A.C.
 Switch S-1 - Set to STROBOTAC LOW
 Drum Scale - 3600 R.P.M.
 Switch S-6 - Set to DIRECT

16.0 CAPACITOR VOLTAGES - D.C.

Measured as in Section 15.0.

FROM	TO	VOLTAGE
C-1	Ground	125
C-2	Ground	125
C-8	Ground	255
C-9	Ground	185
C-11	Ground	132

CONDITIONS: Same as Section 15.0.

TYPE 631-BL STROBOTAC

PARTS LIST

RESISTORS		C7*	631-326
R1	3 k ±5%	0.00516 ±3%	631-326
R2	15 k ±5%	20 +50%-10%	COEB-3-2
R3	51 k ±5%	20 +50%-10%	COEB-3-2
R4	1 M ±5%	500 µf ±10%	COM-20B
R11	5 k ±10%	10 +50%-10%	COEB-3-2
R12	200 k ±10%	0.005 ±10%	COM-35B
R13	50 k ±5%		
R15	1 M ±1%		
R16	1 M ±1%		
R17	51 k ±5%		
R18	51 k ±5%		
R19	24 k ±5%		
R20	22 k ±10%		
R21	10 k ±5%		
R24	1.8 k ±10%		
R25	10 k ±10%		
CAPACITORS. Capacitances are in µf unless otherwise indicated.			
C1	1 ±10%		
C2	2 ±10%		
C4*	0.01538 ±3%		
C5*	0.01538 ±3%		
C6*	0.00516 ±3%		
*C-4/C-6 must = 2.96 to 3.00			
*C-5/C-7 must = 2.96 to 3.00			
TUBES			
V1	RCA		
V2	Sylvania	6X5-GTG	
V3		6N7-GTG	
		631-P1	
MISCELLANEOUS			
F1	FUSE, 0.6 amp	Slo-Blo 3AG	FUF-1
F2	FUSE, 0.6 amp	Slo-Blo 3AG	FUF-1
J1	JACK		CDSJ-1281
P1	LAMP, 6-v Mazda #46		2LAP-330
PL1	PLUG		ZCDPP-10
S1	SWITCH		SWRW-1278 -2
S4	SWITCH, dpst		Part of SWRW-1278 -2
S5	SWITCH, spst		SWRW-1280
SO1	SOCKET		CDMS-1262-2
T1	TRANSFORMER		631-415-2

TYPE 631-BL STROBOTAC

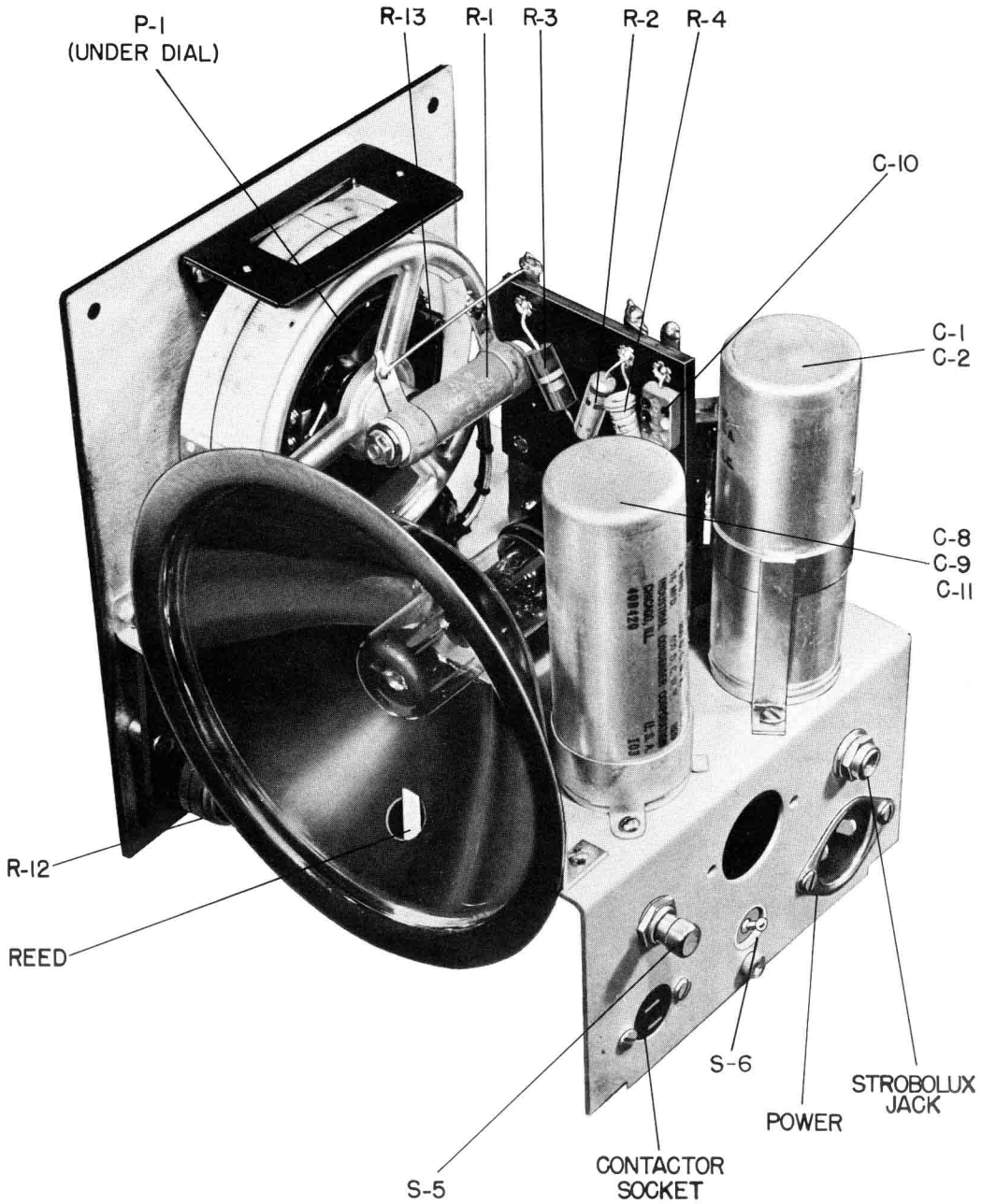

GENERAL RADIO COMPANY

